

**Direct
Ergonomics**

WORKSTATIONS

MONICO



Approved Supplier
SCCB Contract No. c1006



MAKE YOUR SPACE YOUR OWN

MONICO

ABOUT THE SYSTEM

The Monico is the first-ever workstation introduced in Australia with a unique rail system, designed to increase the levels of mobility, adaptability and functionality needed in the workspace today.

In an ever-changing corporate landscape, the flexible design of the Monico means you can easily alter and transform your workspace with minimal costs to meet new and changing needs.

INNOVATION

Easy access to the data and power outlets through a well - concealed flip-top component panel and clever management of cables beneath the work station means you can stay connected whilst keeping your work area uncluttered, safe and hazard-free.

IN ADDITION

The unique leg design allows for easy side-by-side comfort with no table legs getting in your way and creating unnecessary barriers to a cohesive working environment!

FINISHES

The cable flap is in laminate to match the bench top. Support aluminium can be any choice of powder coat colour you require to seamlessly match your unique work space.

CUSTOMISATION

Personalise your work area with a variety of accessories designed to increase work place organisation and productivity. Our accessories enable each user to have a customised workstation.

MODULARITY

The Monico can grow and adapt with you. Our unique system makes it possible to add onto your existing cluster keeping up with your ever-changing needs and work styles.

WARRANTY / LEAD TIME

10 Years / 3- 4 weeks.



IMAGINE THE POSSIBILITIES

ACCESSORIES

“ORGANISE
THE MONICO
YOUR WAY”

FROM LEFT TO RIGHT

- 1 - Slide-on acrylic screen
- 2 - Cantilever Aerostat Monitor arm
- 3 - Single storage box
- 4 - ZGO Monitor arm
- 5 - Infinite Power/Data/USB
- 6 - Cable flap
- 7 - Mo-hair to conceal cables
- 8 - Slide-on acoustic screen
- 9 - Planter box
- 10 - Retro lamp
- 11 - Round double storage box
- 12 - Monorail rail
- 13 - Acrylic screen
- 14 - Open squared storage box
- 15 - Fabric screen
- 16 - Echo panel screen
- 17 - V bracket shelf

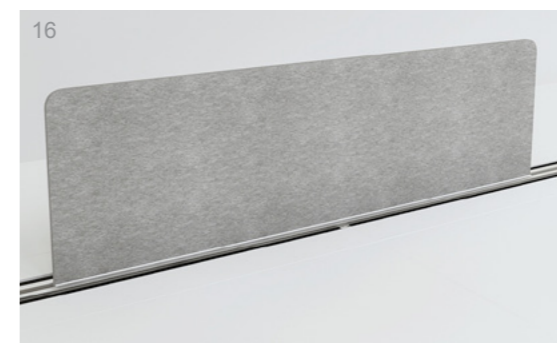
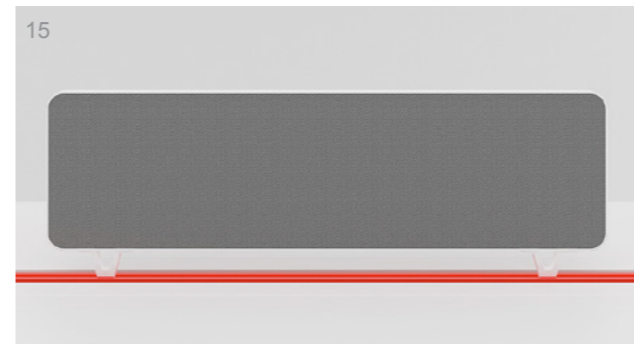
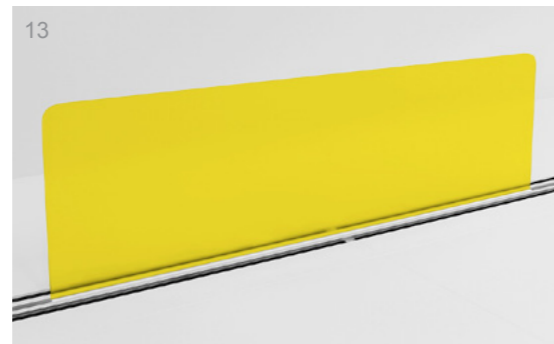
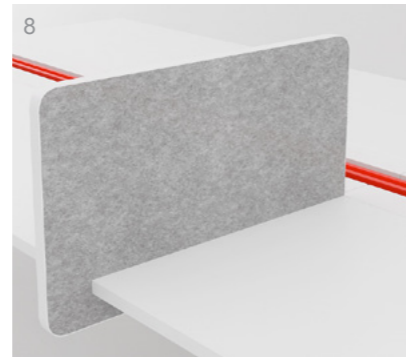
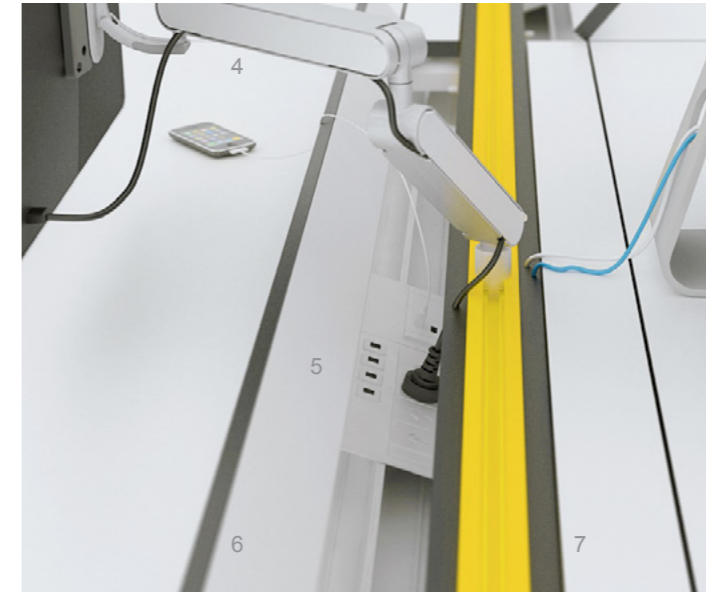
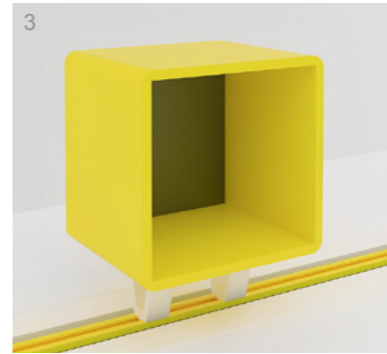
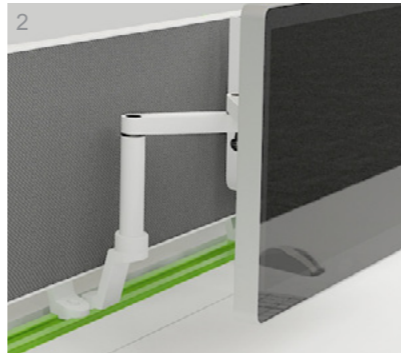
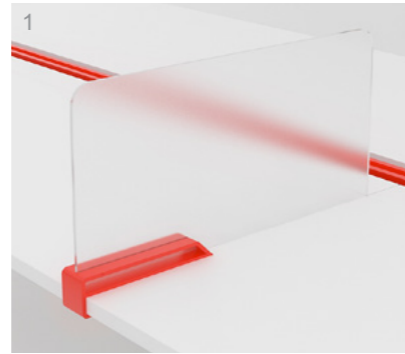

“DETAILS MAKE YOUR DESIGN
WORK”





“AUSTRALIAN
DESIGNED &
MANUFACTURED”



● 120 ° WS 6 DESK

● 90 ° WS 4 DESK +

SPECIFICATIONS MONICO

SPECIFICATIONS // CONFIGURATIONS MONICO

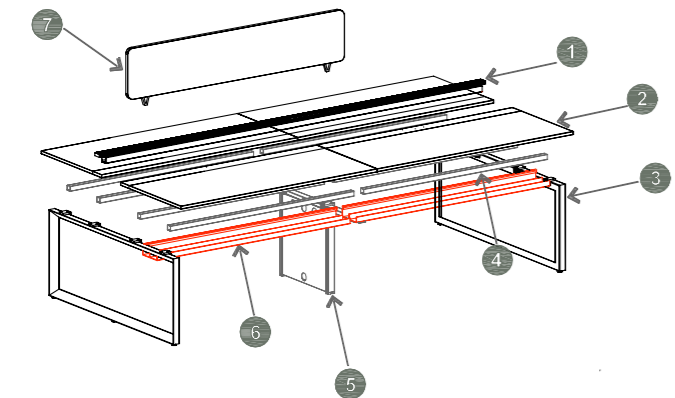

- 1 Monico profile.
- 2 25mm worktops (Square edged shown).
- 3 Delta leg.
- 4 Stretcher beam support.
- 5 In-line leg / cable management option.
- 6 Monico cable gutter (option).
- 7 Monico screen.

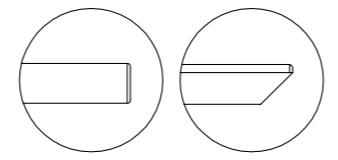

Choice of square edge or sharknosed edge.
Choice of laminate material and edgeband.

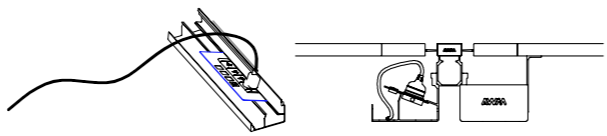

Detail of power/usb & data cable gutter.

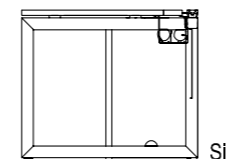
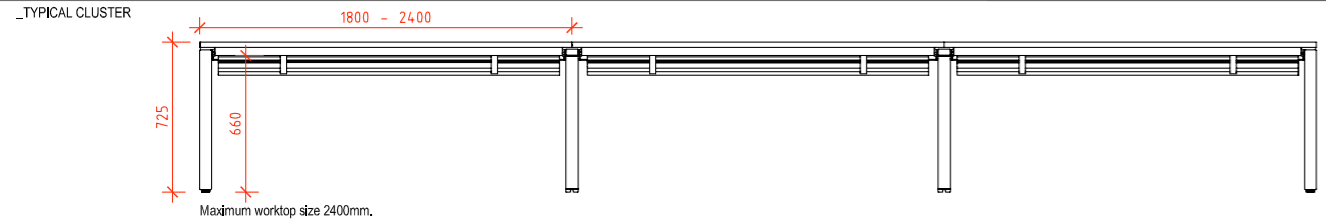

Single Sided

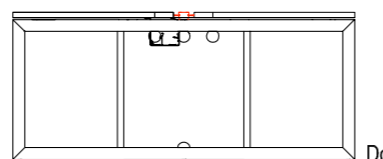
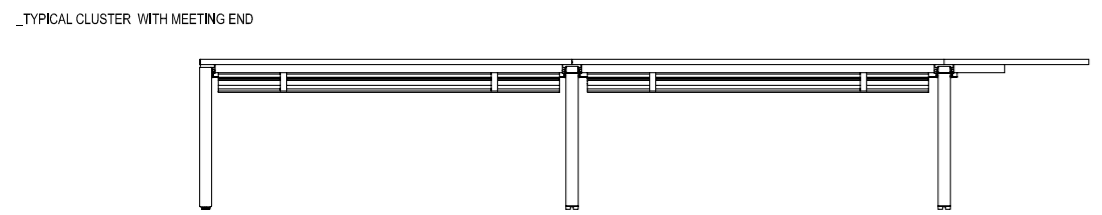

Double Sided

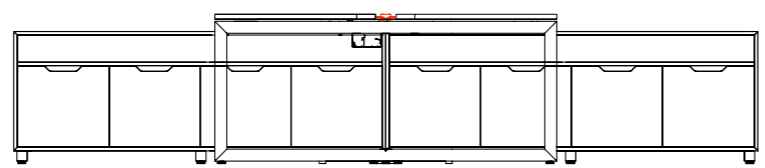
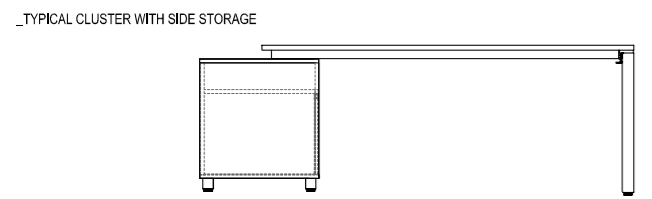

DESCRIPTION

STRAIGHT BENCH, Single sided Leg based	SS 1 DESK	SS 2 DESK	SS 3 DESK	SS 4 DESK	
SS					
STRAIGHT BENCH, Double sided Leg based	DS 2 DESK	DS 4 DESK	DS 6 DESK	DS 8 DESK	
DS					
90 DEG, Double or single sided Leg based	90 DEG 1 WS	90 DEG 2 WS	2x 90 DEG 2 WS	90 DEG 2 WS T+C	90 DEG 4 WS
120 DEG, Double or single sided Leg based		120 DEG 3 WS	120 DEG 6 WS		
STRAIGHT BENCH, Double sided Side storage, SINGLE					
SS / DS					
STRAIGHT BENCH, Double sided Side storage, SHARED					
DS					
STRAIGHT BENCH, Double sided Side storage, DOUBLE					

SPECIFICATIONS // ACCESSORIES

MONICO

DESCRIPTION

Fabric/ EC Screen/ Whiteboard		<p>Choice of fabric/echopanel and edgeband. Fabric, echopanel and edgeband colours available.</p> <p>Optional Whiteboard laminate finish.</p>
Acrylic Screen/ 6mm Plywood		<p>6mm acrylic colours available. Plywood.</p>
Monitor Arm AEROSTAT		<p>Available in white, black, and silver. Offset brackets are used when monitor arms need to be in front of screens.</p>
Monitor Arm ZGO		<p>Available in white and silver. Inserts available in red, yellow, blue and green.</p>
Slide on screen Acrylic		<p>Fitting is powdercoated white. Other colours are available on longer lead times. 6mm Acrylic colours available.</p>
Slide on screen Fabric		<p>Choice of fabric/echopanel and edgeband. Fabric, echopanel and edgeband colours available.</p> <p>Optional Whiteboard laminate finish.</p>
Lamps		<p>Available in silver.</p>

SPECIFICATIONS // ACCESSORIES

MONICO

DESCRIPTION

Storage Box, Mitered		<p>Storage box, mitered. Choice of exterior and interior melamine colours, and edgeband.</p> <p>Shared boxes have 6mm back and front acrylic panels. Acrylic colours available.</p>
Storage Box, Round MDF		<p>Storage box, rounded. MDF, 2 PAC DULUX colours available.</p> <p>Shared boxes have 6mm back and front acrylic panels. Acrylic colours available.</p>
Storage Box, Round Metal		<p>Powdercoated, Standard finishes from the DULUX or INTERPON range. No powdercoat surcharges for orders 50+.</p> <p>Colours from the oxytech range available upon request.</p>
Storage Box, Butt Join		<p>Storage box, butt join. Choice of exterior and interior melamine colours, and edgeband.</p> <p>Shared boxes have 6mm back and front acrylic panels. Acrylic colours available.</p>
Shelf Metal		<p>Powdercoated, Standard finishes from the DULUX or INTERPON range. No powdercoat surcharges for orders 50+.</p> <p>Colours from the oxytech range available upon request.</p>
Shelf Melamine		<p>18 or 25mm melamine shelf. Melamine colours available. Choice of square or sharknosed edge.</p> <p>Choice of 2mm ABS edge.</p>
Cantilever Storage Shelf		<p>Cantilever Storage Shelf. MDF, 2 PAC DULUX and Laminate colours available.</p>
Planter Box		<p>Planter available in red, white, or grey, fiber glass. DULUX colours available.</p>

“FLEXIBILITY & INGENUITY

“BEING THE MANUFACTURER, makes everything POSSIBLE”

